

2

1

REVISIONS			
REV.	DESCRIPTION	DATE	APPROVED

B

B

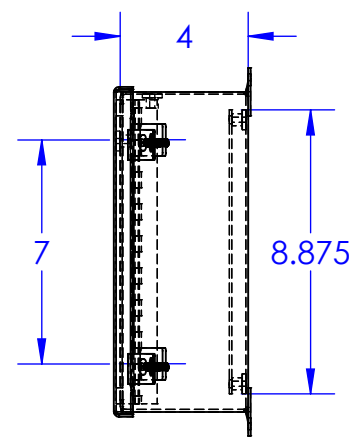
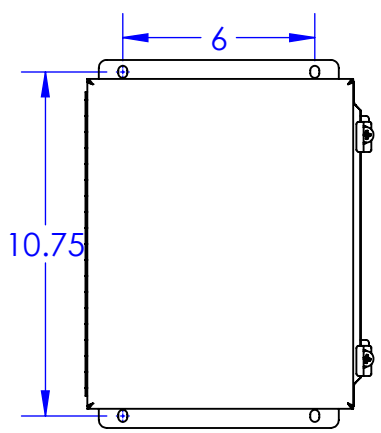
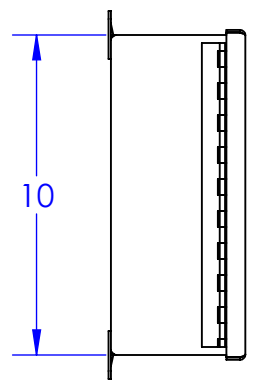
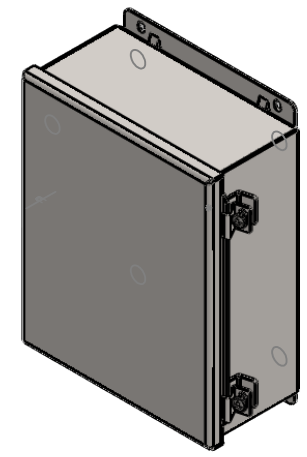
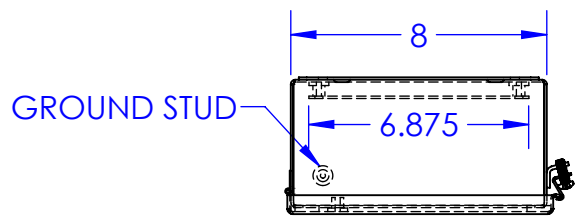

A

A

<p>PROPRIETARY AND CONFIDENTIAL</p> <p>THE INFORMATION CONTAINED IN THIS DRAWING IS THE SOLE PROPERTY OF RALSTON METAL PRODUCTS. ANY REPRODUCTION IN PART OR AS A WHOLE WITHOUT THE WRITTEN PERMISSION OF RALSTON METAL PRODUCTS IS PROHIBITED.</p> <p>UNLESS OTHERWISE SPECIFIED</p> <p>DIMENSIONS ARE IN INCHES</p> <p>TOLERANCES:</p> <p>FRACTIONAL $\pm 1/32"$</p> <p>ANGULAR: MACH $\pm 1^\circ$ BEND $\pm 1/32"$</p> <p>ONE PLACE DECIMAL $\pm 0.1"$</p> <p>TWO PLACE DECIMAL $\pm 0.01"$</p> <p>THREE PLACE DECIMAL $\pm 0.005"$</p> <p>MATERIAL:</p> <p>SEE BOM</p> <p>FINISH:</p> <p>SEE BOM</p> <p>DO NOT SCALE DRAWING</p>	NAME	DATE	<p>50 Watson Road Guelph, Ontario N1L 1E2 Phone: (519) 836-2968 Toll Free: 1-800-265-7611 Fax: (519) 836-9763 www.ralstonmetal.com</p>		
	DRAWN BY	DAVE BURNS		1/28/2019	
	ISSUED BY		CUSTOMER:		
	JOB ORDER NO:		SHOP DRAWING NUMBER:		
	CUSTOMER DRAWING NO:		SIZE	PART NAME:	REV.
	(AUTHORIZED SIGNATURE IN RED)		A	IBOH-100804	-
	THIRD ANGLE PROJECTION		PART NO.	IBOH 100804-DRAWING	
			SCALE: 1:6	WEIGHT: 9.263	SHEET 1 OF 1

2

1