

2

1

REVISIONS			
REV.	DESCRIPTION	DATE	APPROVED

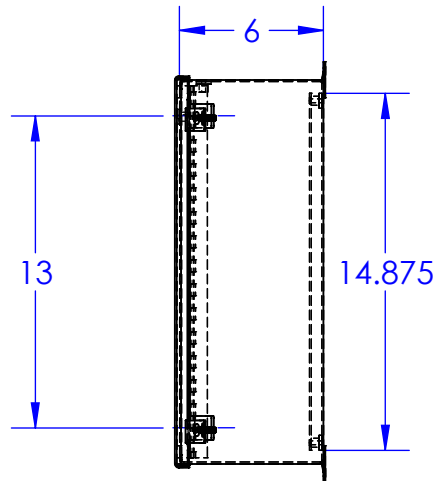
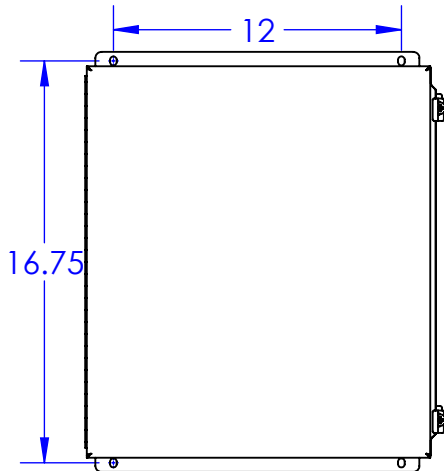
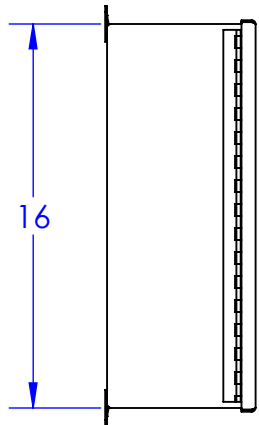
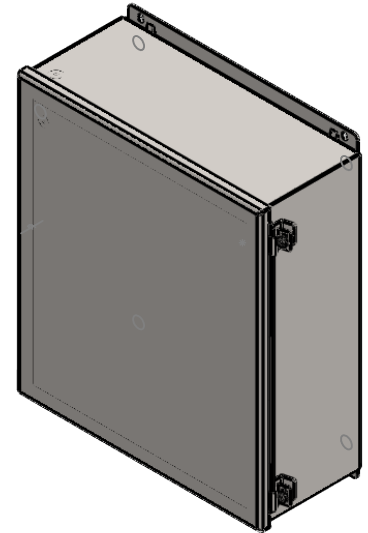
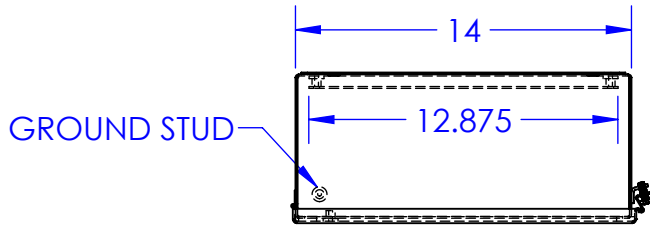

B

B

A

A

<p>PROPRIETARY AND CONFIDENTIAL</p> <p>THE INFORMATION CONTAINED IN THIS DRAWING IS THE SOLE PROPERTY OF RALSTON METAL PRODUCTS. ANY REPRODUCTION IN PART OR AS A WHOLE WITHOUT THE WRITTEN PERMISSION OF RALSTON METAL PRODUCTS IS PROHIBITED.</p> <p>UNLESS OTHERWISE SPECIFIED</p> <p>DIMENSIONS ARE IN INCHES</p> <p>TOLERANCES:</p> <p>FRACTIONAL $\pm 1/32"$</p> <p>ANGULAR: MACH $\pm 1^\circ$ BEND $\pm 1/32"$</p> <p>ONE PLACE DECIMAL $\pm 0.1"$</p> <p>TWO PLACE DECIMAL $\pm 0.01"$</p> <p>THREE PLACE DECIMAL $\pm 0.005"$</p> <p>MATERIAL:</p> <p>SEE BOM</p> <p>FINISH:</p> <p>SEE BOM</p> <p>DO NOT SCALE DRAWING</p>	NAME	DATE	<p>50 Watson Road Guelph, Ontario N1L 1E2</p> <p>Phone: (519) 836-2968 Toll Free: 1-800-265-7611 Fax: (519) 836-9763 www.ralstonmetal.com</p>						
	DRAWN BY	DAVE BURNS		1/28/2019					
	ISSUED BY								
	JOB ORDER NO:								
CUSTOMER DRAWING NO:	CUSTOMER:		SHOP DRAWING NUMBER:						
(AUTHORIZED SIGNATURE IN RED)	<p>THIRD ANGLE PROJECTION</p>		<table border="1"> <tr> <td>SIZE</td> <td>PART NAME:</td> <td>REV.</td> </tr> <tr> <td>A</td> <td>IBOH-161406</td> <td>-</td> </tr> </table>	SIZE	PART NAME:	REV.	A	IBOH-161406	-
SIZE	PART NAME:	REV.							
A	IBOH-161406	-							
	PART NO.	IBOH 161406-DRAWING							
	SCALE: 1:8	WEIGHT: 23.686	SHEET 1 OF 1						

2

1